

45er Laschen

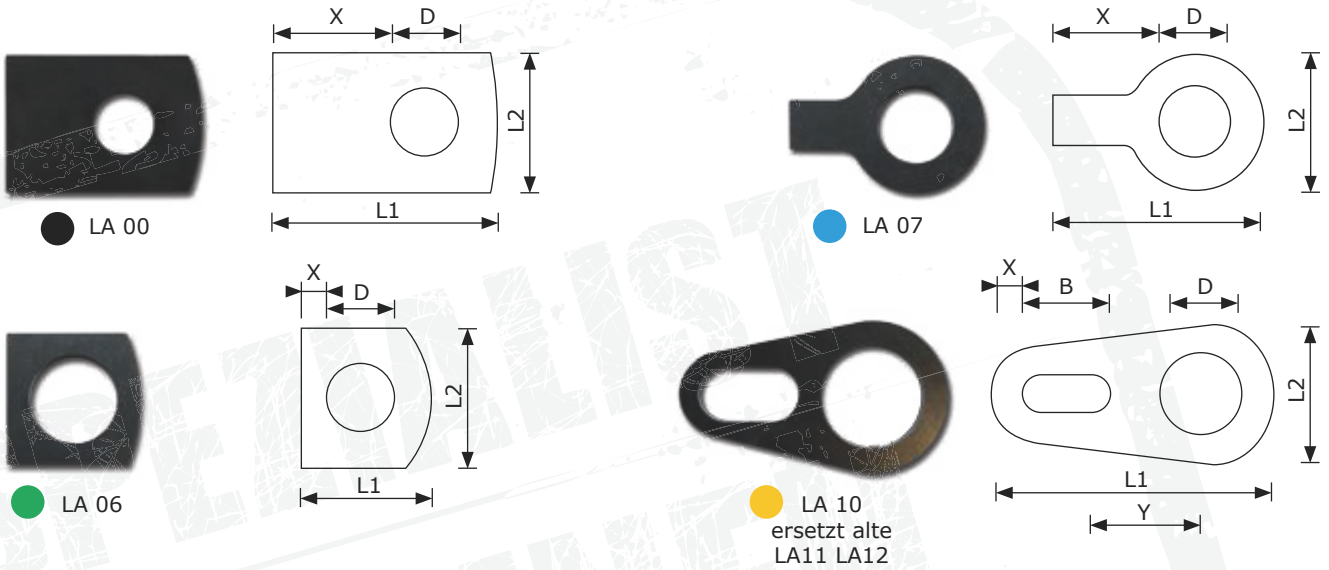

Art	D Ø	L1	L2	X	Y	B	Stärke	Lagernummer
● LA 00	45 mm	115 mm	70 mm	57 mm	-	-	10 mm	901 045 115 070
● LA 06	45 mm	70 mm	70 mm	12 mm	-	-	10 mm	901 045 070 070
● LA 07	45 mm	80 mm	60 mm	27 mm	-	-	8 mm	901 045 080 060
● LA 10	45 mm	105 mm	65 mm	10 mm	50 mm	22 x 25 mm	6 mm	901 045 105 065
● LA 10	45 mm	111 mm	70 mm	6 mm	60 mm	20 mm	8 mm	901 045 111 070

45er Sonderbolzen Greifer



Ø	L1	L3	M	N	A	K	Material	Lagernummer
45 mm	125 mm	150 mm	52 mm	60 mm	79 mm	10 mm	ST52-3**	★ 943 045 125 008
45 mm	147 mm	177 mm	52 mm	60 mm	106 mm	10 mm	ST52-3**	★ 943 045 147 008



Wir empfehlen optional Splint

- ★ 6,3x63 mm
- 10x63 mm

841 094 006 063
841 094 010 063

** Tenifer-QPQ-Härteverfahren mehr zu diesem Thema auf Seite 97
Schmiernippel M10 im Lieferumfang enthalten! Zusätzliche Schmiernippel auf Seite 80
Laschen nicht gehärtet! Material ST52-3

45er Sonderbolzen Greifer



Bohrung 8 mm
Splinte Seite 81

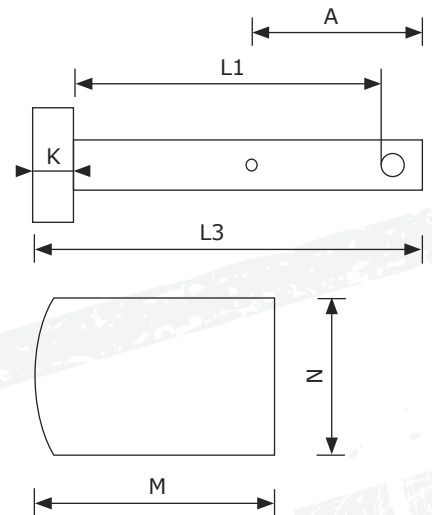
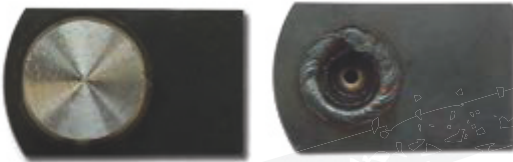

Ø	L1	L3	M	N	A	K	Material	Lagernummer
● 45 mm	Kl.95 mm	120 mm	113 mm	70 mm	62 mm	10 mm	42CrMo4*	■ 943 045 095 008
● 45 mm	Kl.105 mm	127 mm	91 mm	54 mm	67 mm	8 mm	42CrMo4*	■ 943 045 105 008

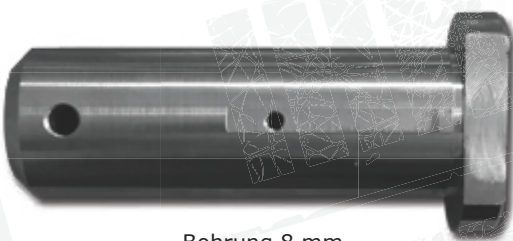

Bohrung 8 mm
Splinte Seite 81

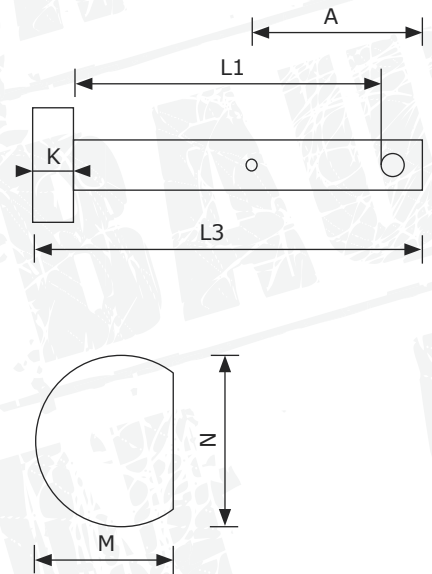
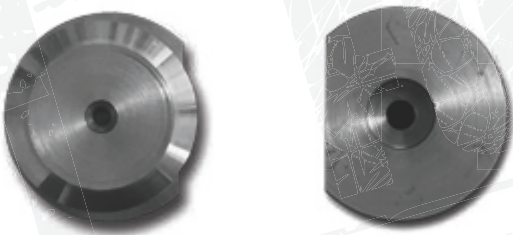

Ø	L1	L3	M	N	A	K	Material	Lagernummer
● 45 mm	Kl.99 mm	130 mm	54,5 mm	64 mm	73 mm	12 mm	42CrMo4*	■ 943 045 099 008
● 45 mm	Kl.109 mm	140 mm	54,5 mm	64 mm	82 mm	12 mm	42CrMo4*	■ 943 045 109 008
● 45 mm	KL.152 mm	180 mm	52,3 mm	60 mm	110 mm	10 mm	42CrMo4*	■ 943 045 152 008



Wir empfehlen optional...
● Klappstecker 60x10 mm

841 060 059 010

* 72h langzeit gasnitriert, gehärtet und geschliffen
Schmiernippel ● M8 ● M10 im Lieferumfang enthalten! Zusätzliche Schmiernippel auf Seite 80

45er Sonderbolzen

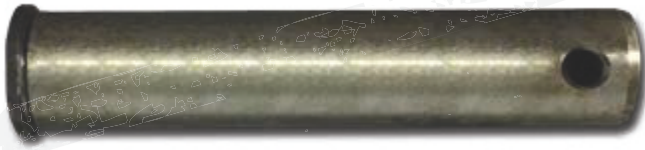

Bohrung 13 mm
2x Schmieraustritt A1 / A2
Klappstecker auf Seite 80

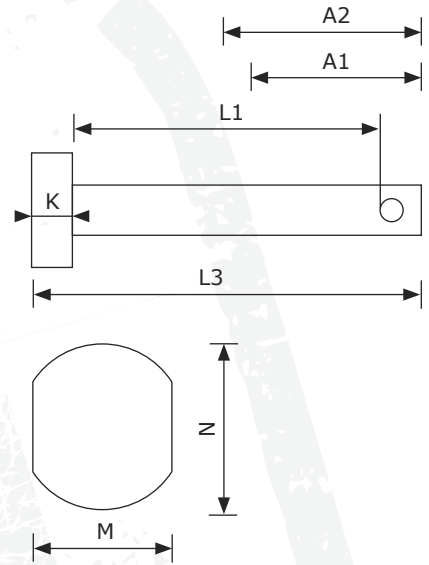
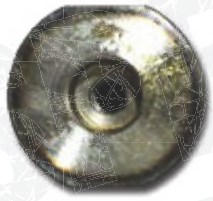

Ø	L1	L3	M	N	A1	A2	K	Material	Lagernummer
45 mm	196 mm	230 mm	46 mm	50 mm	79 mm	184 mm	6 mm		908 045 196 013 ★



Bohrung 13 mm
2x Schmieraustritt A1 / A2
Klappstecker auf Seite 80

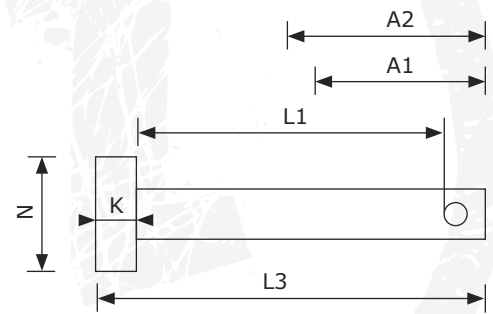
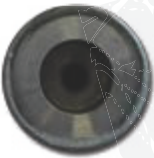

Ø	L1	L3	N	A1	A2	K	Material	Lagernummer
45 mm	226 mm	253 mm	50 mm	81 mm	194 mm	5 mm		908 045 226 013 ★



2x Bohrung 13 mm
Klappstecker auf Seite 80

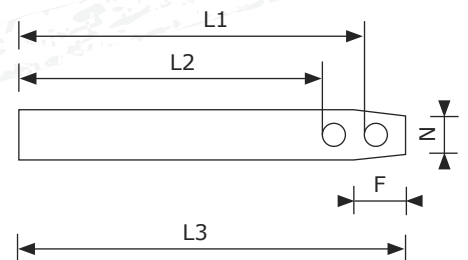

Ø	L1	L2	L3	F	N	Material	Lagernummer
45 mm	339 mm	313 mm	356 mm	22 mm	37 mm		906 045 313 013 ★



Wir empfehlen optional Splint

■ 6,3x63 mm
★ 10x63 mm

841 094 006 063
841 094 010 063

Schmiernippel M10 im Lieferumfang enthalten! Zusätzliche Schmiernippel auf Seite 80

45 mm